



**FRONTO  
SLAT PANELS**



# INTRODUCTION

FRONTO. SLAT PANELS 07

DESIGNER 09

DISCOVER A WORLD OF POSSIBILITIES 10

# FRONTO SLAT PANELS

BENEFITS 17

TECHNOLOGY 19

COLOURS 21

INSTALLATION 24

THINKING ABOUT NATURE 26







# FREEDOM OF CREATION

VOX is a European brand that has been steadily strengthening its position as one of the most innovative companies in the interior and home finishing sector for over 30 years. It is present in over 50 countries on all continents. VOX has been in India since 2018 with innovative ceiling and wall products.

At VOX, we believe that freedom begins at home, and that what matters more than a particular style is the personal needs and lifestyle of the people in your home. Therefore, our goal is to inspire, advise and provide comprehensive solutions - matching collections of furniture doors, floors, decorative panels and façades.









# FRONTO. SLAT PANELS

Fronto is a new solution for façade and soffit. Depending on your needs, you can choose panels in a standard version, which will be perfect for interior ceilings or the panels manufactured using the innovative Max-3 technology. Thanks to it, the profile is extremely resistant to impacts and large temperature fluctuations. These properties make the product ideal for outdoor use. Fronto panels are waterproof, lightweight, maintenance-free, as well as quick and easy to install. This guarantees many years of trouble-free use. It is worth emphasizing that the panels are designed and manufactured in Europe.









# DESIGNER

„For some time now, we have been able to observe an interest in spatialising walls in interiors, and dressing them with 3D decorative elements. Especially popular nowadays are slat panels, which are mostly used for decorating single walls. These walls have also slowly started to „come out“ from houses covering balcony niches or terraces. Interiors and exteriors exchange furniture, accessories, and wall coverings.

Hence came the idea for Fronto, to develop a new panel with a modern lamella shape.

When designing the profile, I wanted to achieve the deepest possible shading between the lamellas. As a result, thanks to specially designed joints, the shadow impressively exposes individual lamellas. In this way, we achieved an effective three-dimensionality.”



**DOROTA BALEWICZ**



# DISCOVER A WORLD OF POSSIBILITIES



Fronto is a versatile product that offers many design possibilities. The shape of the profile allows vertical and horizontal installation. Additionally, it can be combined with other VOX façade panels. Thanks to the range of patterns imitating the structure of wood, this creates unique designs both on the wall and on the ceiling. Depending on the project, Fronto will work well on the entire building or as a single touch on the façade.



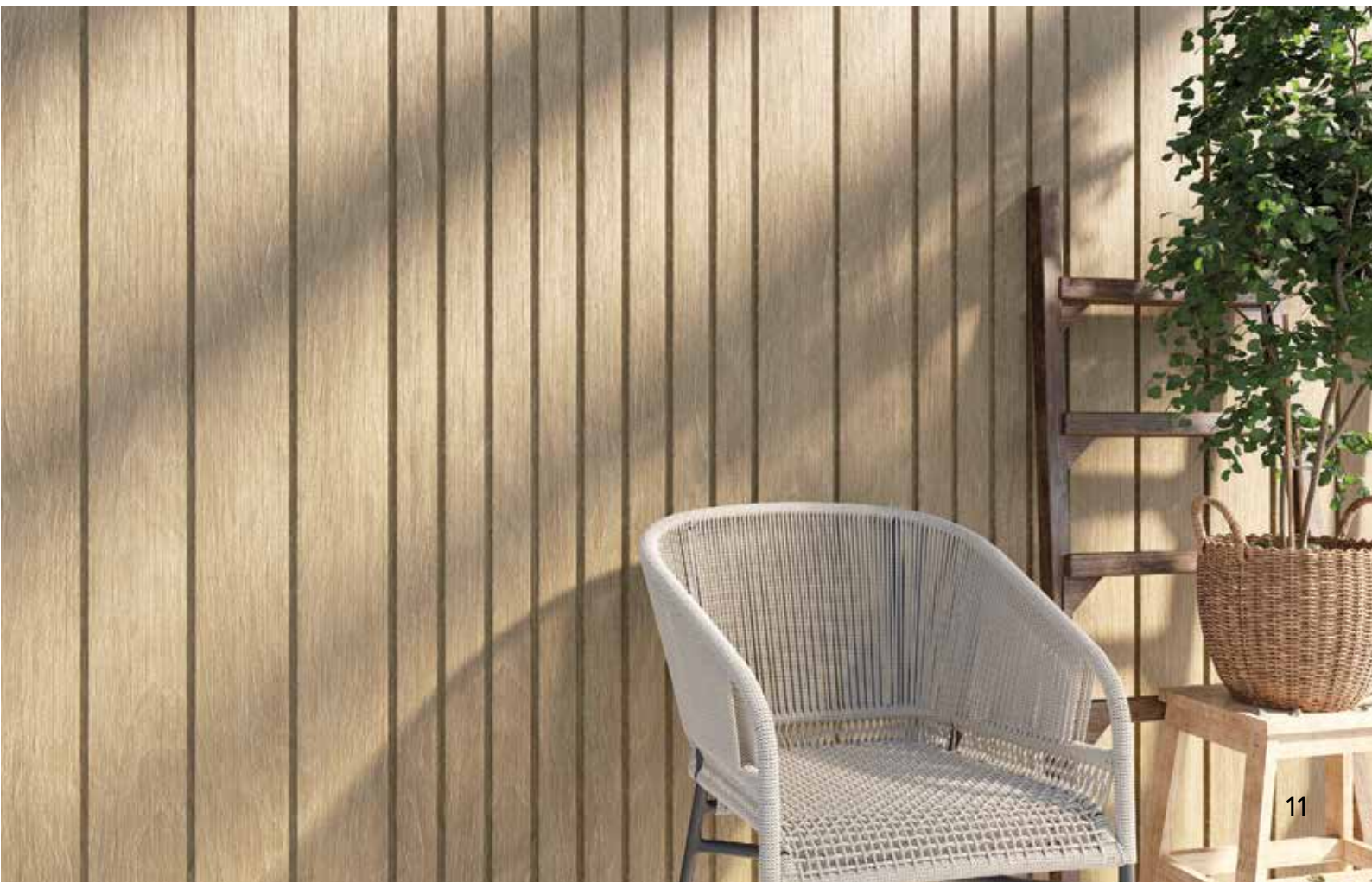



# VERTICAL VERSUS HORIZONTAL



Fronto panels can be installed in two ways - vertically or horizontally. The former gives the wall a modern and elegant look and great visual effect. The latter, through an elongated arrangement of lines, gives the wall a calm rhythm.

Panels can also be used as a decorative element, if we cover only a selected fragment of the elevation by placing them horizontally or vertically.



# ON THE WALL AND ON THE CEILING



„A sense of atmospheric cosiness can be achieved by laying panels on the wall and ceiling at the same time. This arrangement makes the sharp angle invisible, and the two perpendicular planes blend seamlessly and aesthetically.”

DESIGNER  
DOROTA BALEWICZ

# COMPREHENSIVE OFFER



Thanks to the universal connection and assembly system, we can combine different panel collections such as the Max-3 system and the Infratop soffit on the façade and ceiling. This creates almost unlimited possibilities for creating compositions on different planes. The varying width of the elements combined in an individual rhythm will create the visual unity for the house.



# HARMONY IN THE INTERIOR



Fronto can also be installed indoors. Three-dimensional panels mounted on a flat surface will introduce a visual variety to your interior. Such a wall will look different at any time of the day thanks to the picturesque play of light and shadow. You can combine it with a ceiling of the same colour.

# MODERN SOLUTIONS

## HURRICANE RESISTANT LOCK

This solution ensures better adhesion of the panels to the façade, and eliminates the noise the panels make in strong winds.

## SYSTEM CLICK

A simple and quick way to connect panels on the façade and soffit.

## MOUNTING HOLES

Pre-drilled mounting holes make installation quick and easy.

## 3D EFFECT

Light plays in the folds of the panels, creating interesting chiaroscuro, and the joints appear darker, which further enhances the 3D effect.

## SELF-CLEANING STRUCTURE

The façade is easy to keep clean thanks to the special structure of the panel, on which dirt and dust does not settle.





# ADVANTAGES



## DESIGN

A perfect reflection of the colour and grain of the wood.



## WATER-RESISTANCE

Panels and finishes are waterproof.



## CONSERVATION

It does not require maintenance, which is time-consuming and expensive.



## DESIGN CAPABILITIES

The panels can be used both on the wall as well as on the ceiling.



## LIGHTNESS

Panels are lightweight and do not weigh down the structure.



## MADE IN EUROPE

The panels are designed and manufactured in Europe.







# MAX-3 TECHNOLOGY

## INNOVATIVE TECHNOLOGY

The three-layer technology used in the production of Max-3 makes the panels combine high mechanical resistance with the possibilities of the polymer material in terms of shape, colour and structure.

## TEMPERATURE RESISTANCE

The panels are characterized by reduced linear expansion, which ensures their high resistance to both low and very high temperatures. Thanks to this property, panels made in the Max 3 technology can be used outdoors.

## DURABILITY OF METAL

The base layer of the panel is its core, which gives it a test-proven durability comparable to metal. Importantly, Max-3 panels do not corrode and do not load the structure.

## BOTTOM

---

## INTERMEDIATE

---

## DECORATIVE LAYER

---



See the impact resistance test provided by the Max-3 technology.







# VERSATILE COLOURS

Materials in wood colours are versatile, and offer many design possibilities. For this reason, they are often chosen for façade and ceiling finish. The colors of the wood in the interior add coziness and warmth which creates a timeless feature. Fronto is available in five wood finishes. Thanks to the use of modern digital printing technology (Thermoprint, Thermoprint 2), the panels have a matt finish, with an interesting and diverse pattern, and without the effect of repetition. All these features create a result which is closer to the perception of natural material. Wood-coloured façades and soffits blend well with other materials such as stone, plaster or brick.





OAK



HONEY OAK



WINCHESTER OAK





GOLDEN OAK



WALNUT



# TROUBLE-FREE INSTALLATION

## TYPICAL DESIGN AND TOOLS

The panels are mounted on a standard substructure (metal or wooden) without the need for special tools.

## FINISHING TRIMS

Trims 11, 11.5, 12, 13, 15 and 18 are versatile, and can be used in both Fronto and Max-3 panel installations as well as Infratop soffit.

## INSTALLATION POSSIBILITIES

The panels can be installed in a variety of ways: vertically or horizontally, on the wall or ceiling, or combined with Infratop soffit panels or the Max-3 façade system.

## FAST AND CLEAN

Slat panels mean clean installation with no dust during processing. The click system and pre-punched mounting holes streamline their connection, which greatly reduces installation time, outperforming plaster and wooden façades.





# SYSTEM ELEMENTS

**SV(P/PU)-06** for indoor use

**SX(P/PU)-06** for outdoor use

Slat panel

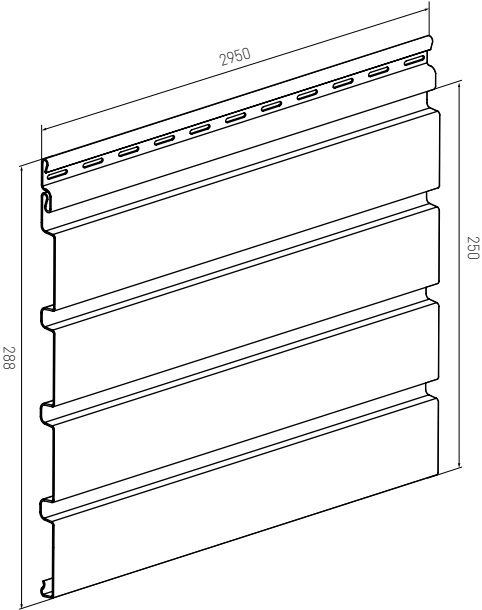

**SV-11**

Starter trim

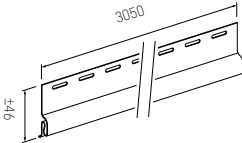

**SV-11,5**

Lower ventilation trim

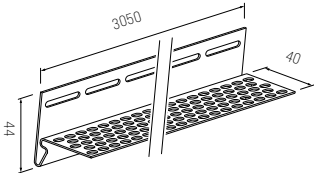

**SV(P/PU)-12**

Outside corner

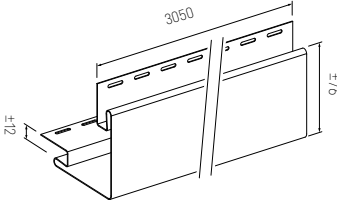

**SV(P/PU)-13**

Inside corner

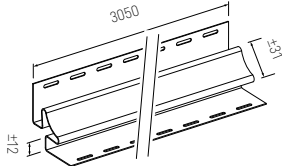

**SV(P/PU)-15**

J trim

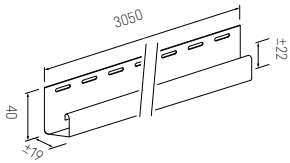

**SV(P/PU)-18**

Joint trim

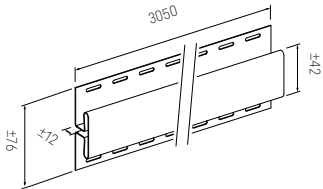

Scan QR code to see detailed installation instruction



# THINKING ABOUT NATURE



## RECYCLING

Our products are made of thermoplastics, which are fully recyclable. We use recycled materials in production. Depending on the product, the weight of recyclable materials is up to 80% of the total.



## DURABILITY

Our products are extremely durable. The lifetime of many is 10 or even 30 years. Thanks to the resistance to a variety of external factors, their impact on the environment is significantly smaller than products with more frequent replacement causing additional wear raw materials, energy and waste generation.



## MAINTENANCE

There is no need for maintenance over the entire lifetime, and therefore no additional chemicals (paints, preservatives, etc.) must be used, which means no harm to the environment.



## INSULATION

Our claddings ensure proper ventilation of the facade and protect it against moisture. Additionally, they are an excellent cladding in the system of ventilated facades, which improves efficiency of heat of the building and reduces the need to burn fuels for heating purposes.



## HEALTH

Our products are safe for health. They do not contain harmful substances (e.g. lead or cadmium) and do not release volatile organic compounds.

















## CARBON FOOTPRINT

Our materials contain mineral fillers and additives derived from renewable raw materials, which reduces the carbon footprint of up to 40% compared to products made only of synthetic polymers.



# PRODUCT FEATURES

FEATURE	NORM	TEST RESULT	UNIT
 <p>Low weight Facilitates transport and mounting</p>		SV(P/PU)-06: 2,23 SX(P/PU)-06: 2,37	kg/m <sup>2</sup>
 <p>Water resistance</p>			
 <p>Impact resistance</p>	PN-EN 13245-2:2009/AC:2010	Not less then 3J (-20,03oC), 3J (23,03oC)	J
 <p>Incombustibility It does not burn, it melts</p>	PN-EN 13245-2:2009/AC:2010	D-s3;d0	
 <p>Resistance to UV rays Colour resistance</p>	PN-EN 20105-A02:1996 PN-EN 13245-2:2009/AC:2010	not more than 3 SV/SX-06 A.8.60 SVP/PU SXP/SXPU-06 A.4.60	grayscale grade
 <p>Lead and tin free</p>			
 <p>Resistance to changing weather conditions</p>			
 <p>Quick installation Wide covering width, built-in locks and factory made nail slots facilitate and speed up the installation</p>			
 <p>System Click Thanks to it, the assembly is easy and fast</p>			
 <p>Design possibilities The panels can be used both on the wall and on the ceiling.</p>			
 <p>Maintanace free No need for painting and other treatment</p>			
 <p>Easy to keep clean Can be clean with water and mild detergents</p>			
 <p>Recycled product 100% recyclable</p>			
 <p>10-year warranty on the product</p>			



VOX BUILDING PRODUCTS PRIVATE LIMITED

6th Floor, Leela Collonnade, The Leela Palace, No.23, HAL Old Airpo™ Road, HAL 2nd Stage,  
Kodihalli, Bengaluru - 560008, India

Ph No: +91 8043741810

Email: [customercare@voxindia.co](mailto:customercare@voxindia.co)



[voxindia.co](http://voxindia.co)