



KERRADECO
WALL SYSTEM

VOX

INDEX

04

FREEDOM
BEGINS AT HOME

08

MULTIPLE
USE



10

KERRADECO
STONE LINE



28

KERRADECO
WOOD LINE

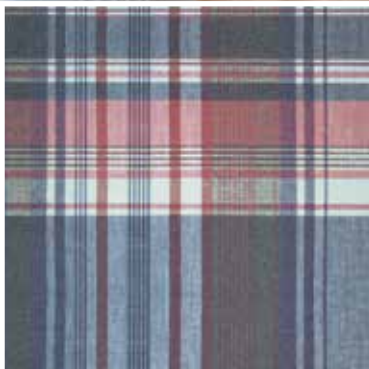

06

KERRADECO.
THE IDEAL
ALTERNATIVE

44

KERRADECO
TEXTILE





48

**KERRADECO
UNICOLOR**

54

**QUICK
INSTALLATION**



56

ADVANTAGES

57

**PRODUCT
AND ACCESSORIES**



52

**KERRACORE.
INNOVATIVE
TECHNOLOGY**

58

SUMMARY

FREEDOM BEGINS AT HOME

At VOX we believe that true freedom begins at home, and the interior is more about your individual needs and lifestyle rather than a specific style. This is why we inspire, advise and provide comprehensive interior design solutions – furniture, door, flooring and wall system collections matching one another.

The philosophy of the VOX Group is reflected in its membership in the Human Touch Group. The organizations, companies and entities affiliated with HTG share a common belief that the primary value of all business activities should be man and meeting man's actual needs. This idea assumes that each of us is, on the one hand, a company partner in its current activity, but also the main motivation for its development and possible changes.

VOX is a European Company operating in the building materials and home furnishing market. We are offering an extremely wide range of products for the construction and arrangement of houses, flats and public buildings. Our product portfolio includes over 200,000 products - furniture, doors, cladding, internal wall systems, ceilings and skirting boards. We have been operating on the market since 1992. Our 6 high-tech factories at EU and Belarus serving not only the Polish market, but also over 45 markets in 4 continents. In India we established a joint venture company with the former founders of Ashirvad Pipes.





KERRADECO. THE IDEAL ALTERNATIVE

KERRADECO wall system is an ideal alternative to traditional solutions, such as MDF boards, wood, ceramic tiles, decorative plaster or wallpaper. KERRADECO will change your interior without the need for cumbersome and time-consuming renovation, in a short space of time.

KERRADECO is resistant to moisture, water and impact. It is durable, non-flammable, increases the sound insulation of the room and is covered by a 10-year warranty. KERRADECO is safe for you and the environment, it does not emit toxic substances, is made of recycled materials and is 100% suitable for recycling. A wide range of designs and surface structures allow you to design beautiful and durable solutions for all types of interiors, including bathroom.





MULTIPLE USE

KERRADECO wall system is a modern and custom way to finish your walls. It is elegant and gives your interior a first-class look and character.

Its overriding feature is its versatility. It allows you to quickly rearrange any room without the need for cumbersome and time-consuming renovation. This is an ideal solution, not only for private flats and houses, but also for public spaces.

KERRADECO is the ideal choice for business: hotels, hostels, apartments for rent, bars, cafes, restaurants and offices. It is the perfect backdrop for works of art, decorative lamps and original interior design. Its quick and easy installation reduces the amount of closure time for premises.





STONE LINE

Stone Ivory

12



Loft Rusty

24



Stone Misty

14



Loft Concrete

22

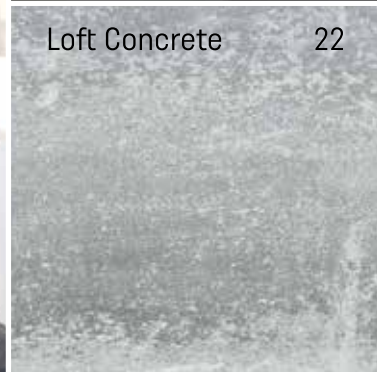

Stone Moon

18

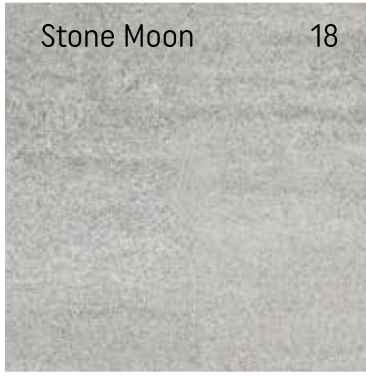

Stone Anthracite

20

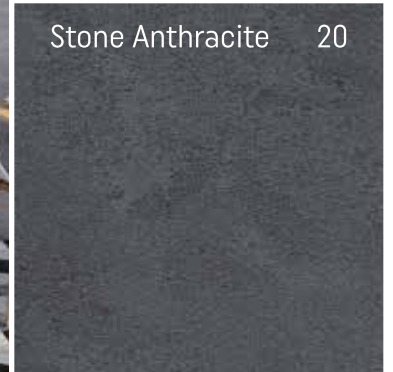

Desert Stone

16



Marble Botticino

26



STONE IVORY

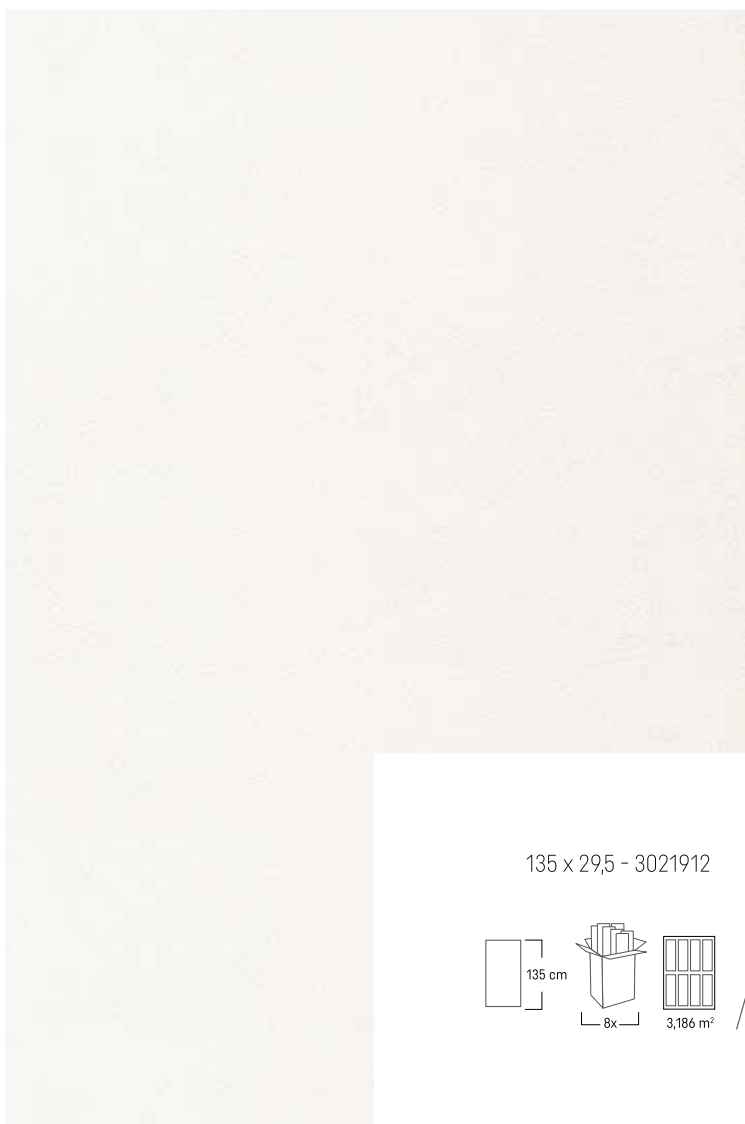

135 x 29,5 - 3021912

270 x 29,5 - 3023893

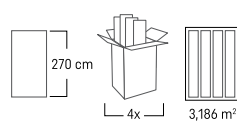
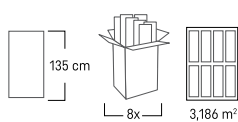



STONE MISTY



135 x 29,5 - 3021872

270 x 29,5 - 3022282

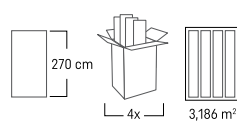
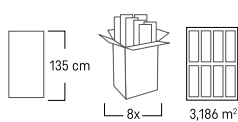



DESERT STONE

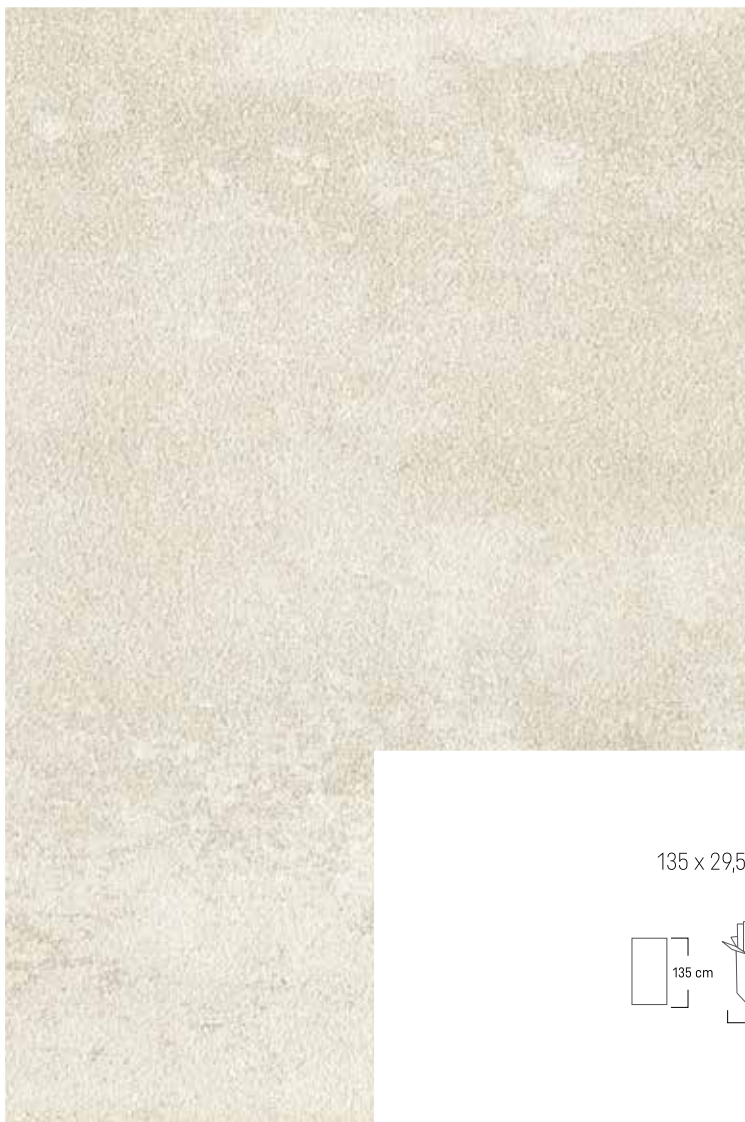

135 x 29,5 - 3021880

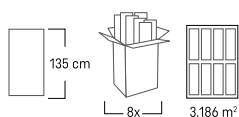

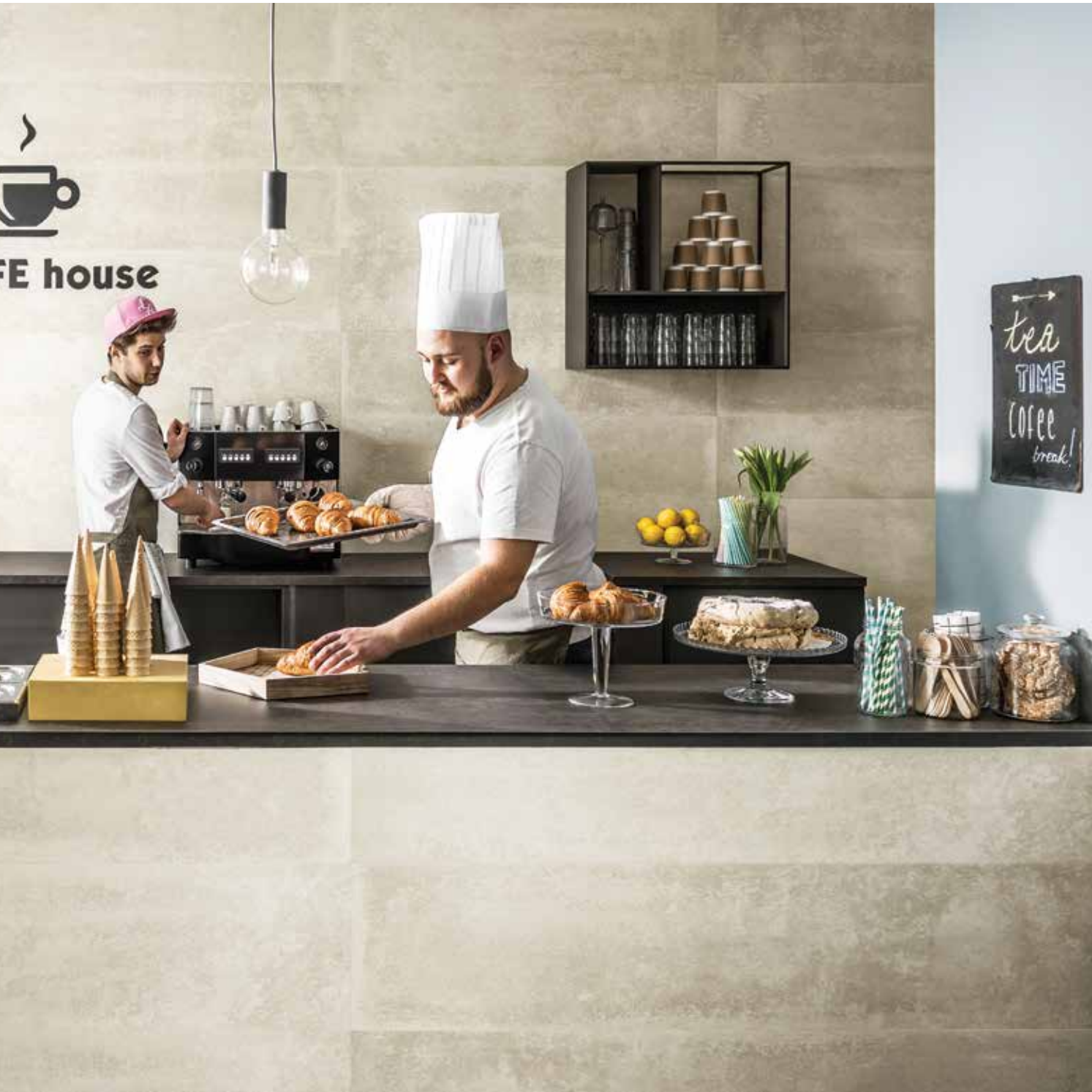

STONE MOON



135 x 29,5 - 3022096

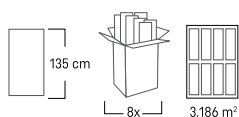



STONE ANTHRACITE



135 x 29,5 - 3021809

270 x 29,5 - 3021811

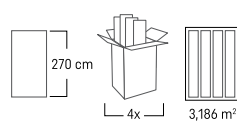
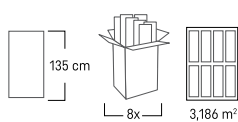



LOFT CONCRETE



135 x 29,5 - 3021913

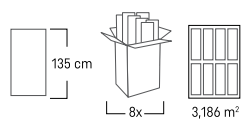



LOFT RUSTY



135 x 29,5 - 3023461

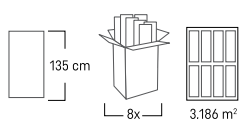



MARBLE BOTTICINO



135 x 29,5 - 3022097

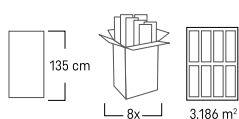



WOOD LINE

Snowy Wood 30



Wood Brandy 32

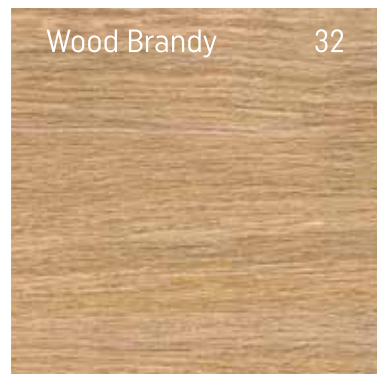

African Wood 34

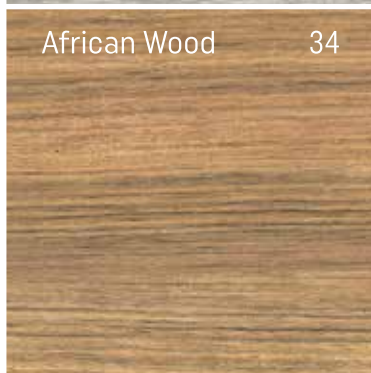

Art 42



Concrete 40

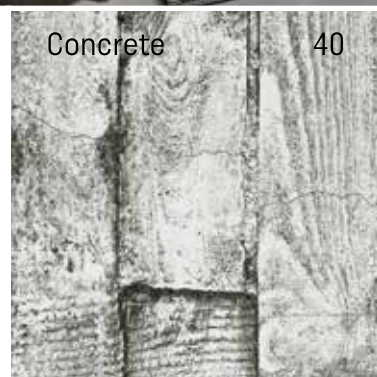

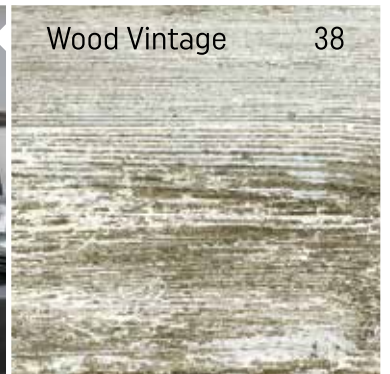

Wood Vintage

38



Wood Carbon

36



SNOWY WOOD



135 x 29,5 - 3022238

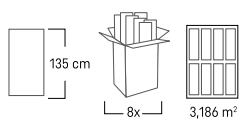



WOOD BRANDY



135 x 29,5 - 3022104

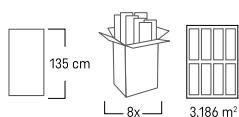

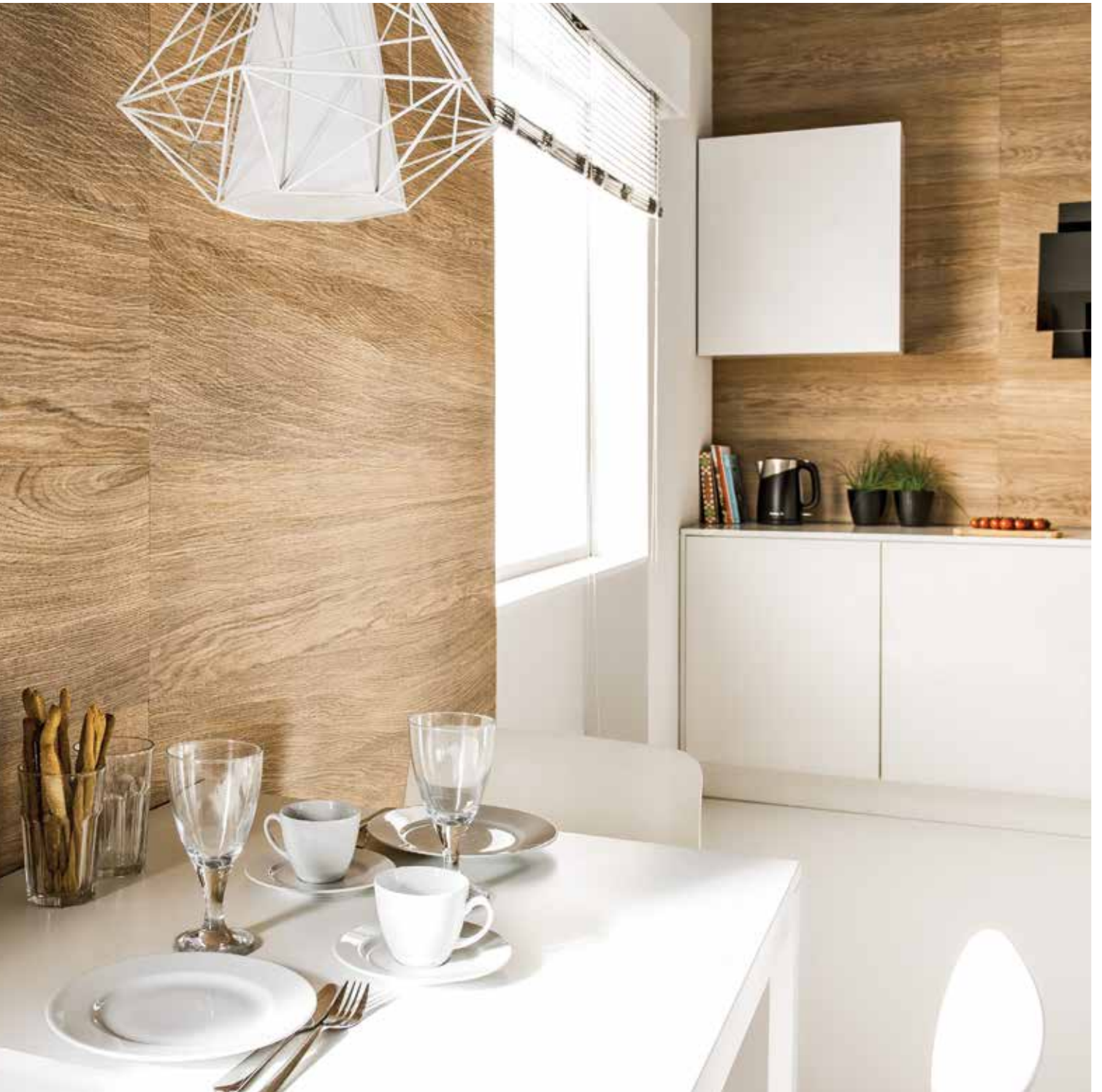

AFRICAN WOOD



135 x 29,5 - 3022105

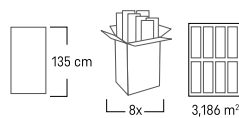



WOOD CARBON



135 x 29,5 - 3021871

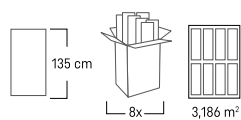



WOOD VINTAGE

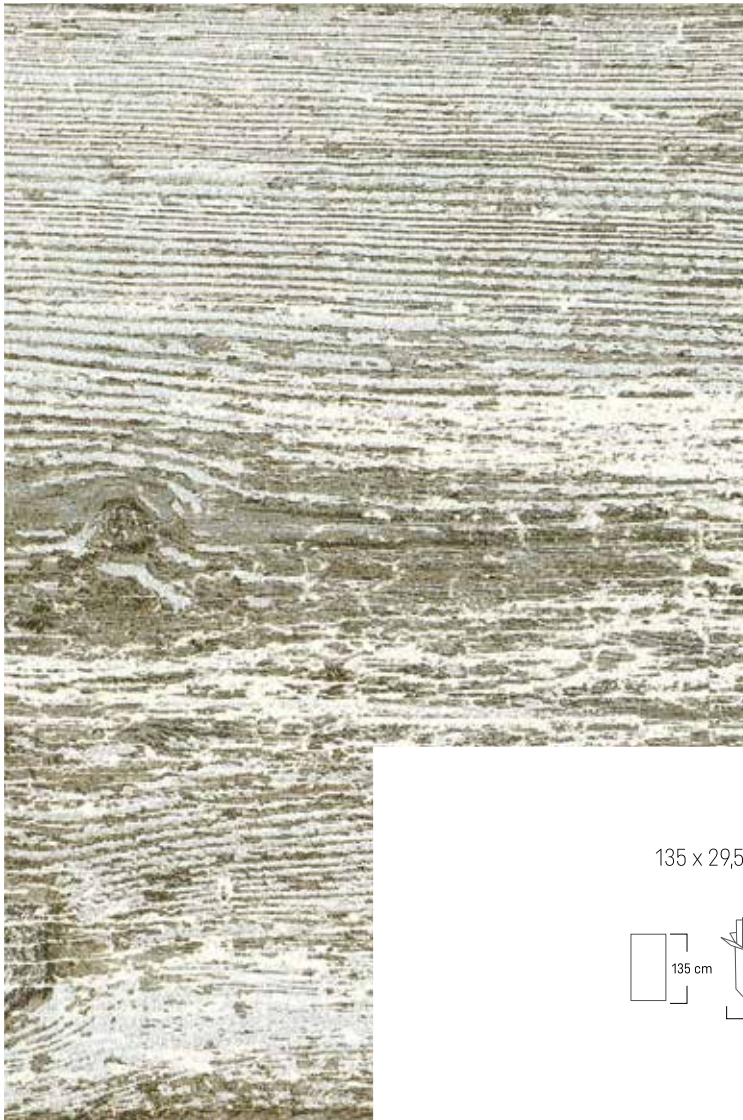

135 x 29,5 - 3022468

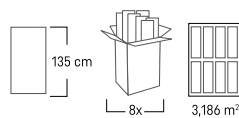



CONCRETE

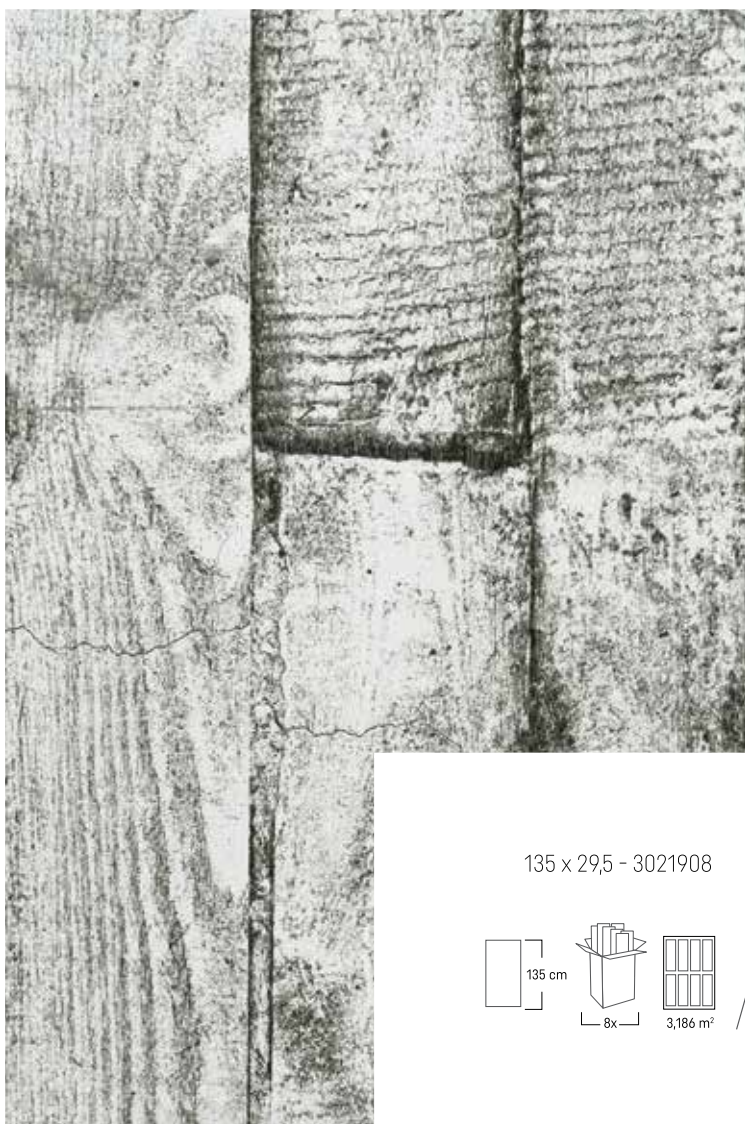

135 x 29,5 - 3021908

270 x 29,5 - 3021903

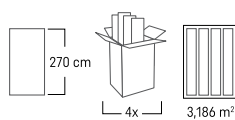
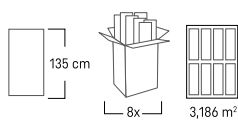



ART

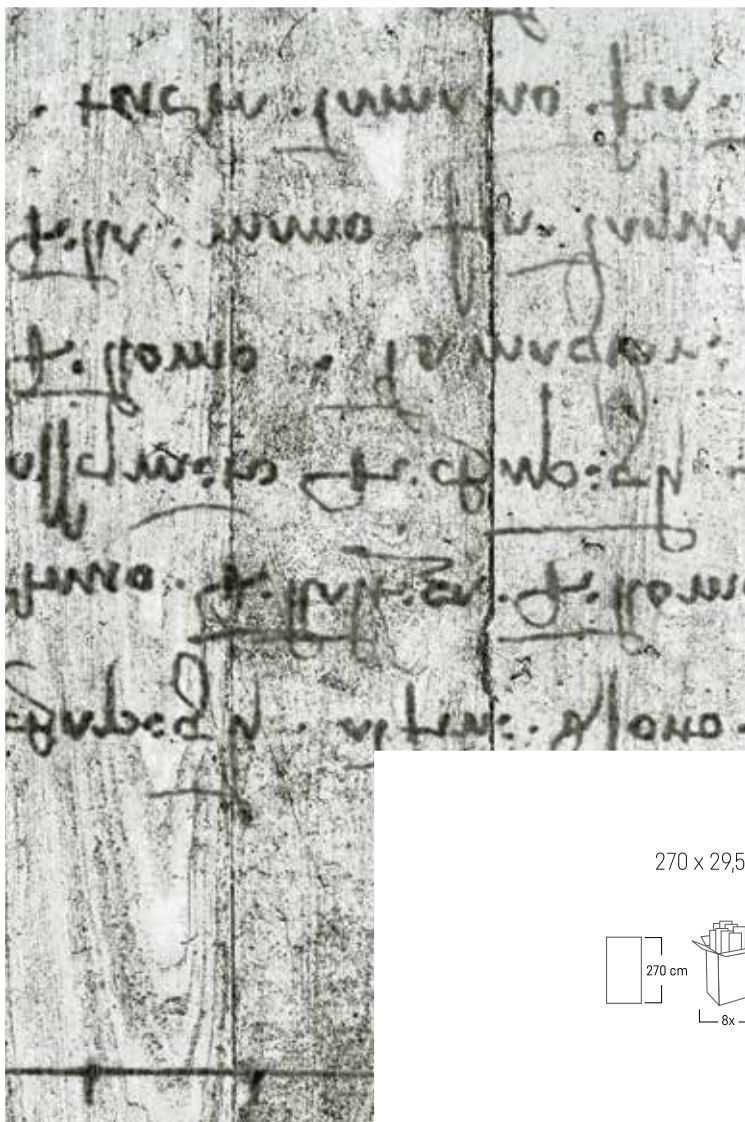

270 x 29,5 - 3009204

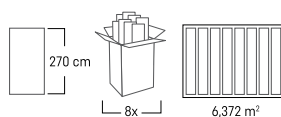



TEXTILE

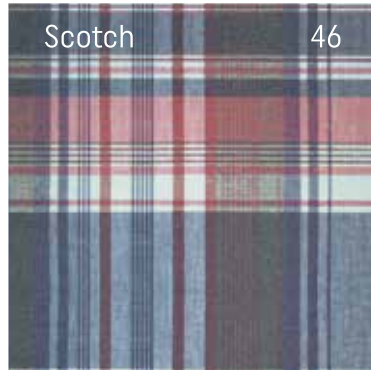



SCOTCH

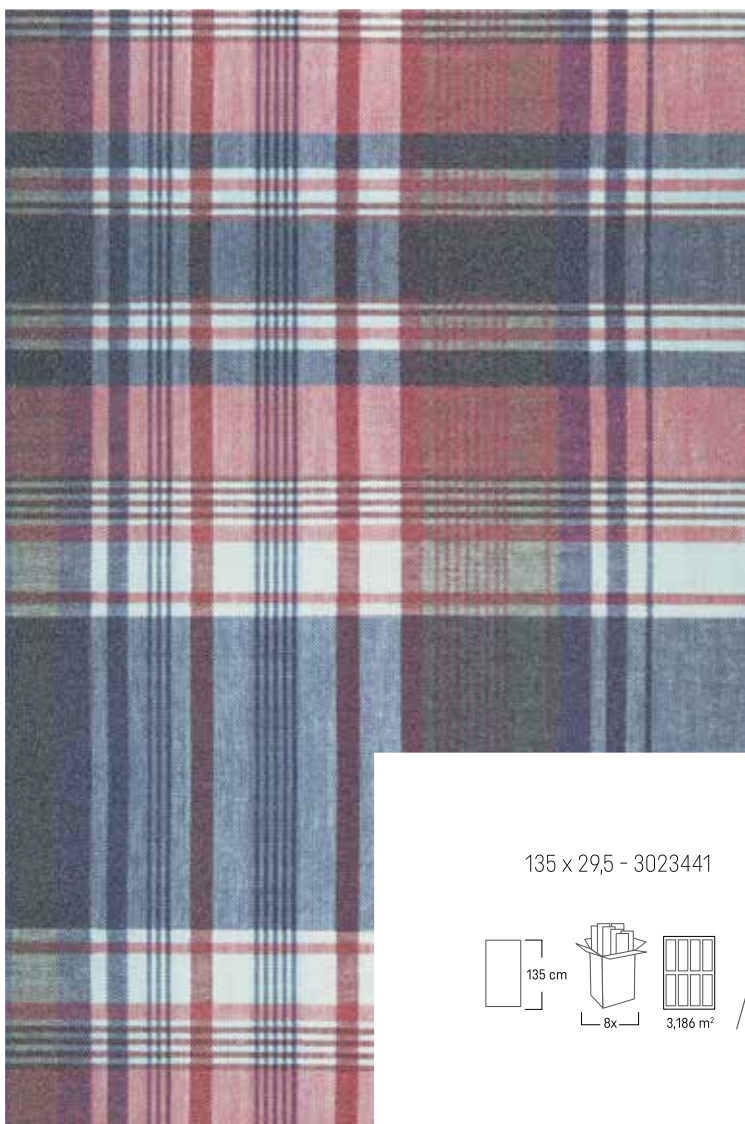

135 x 29,5 - 3023441

270 x 29,5 - 3021878

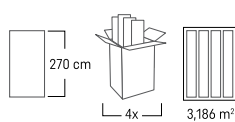
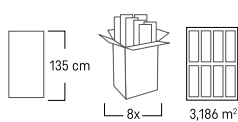



UNICOLOR

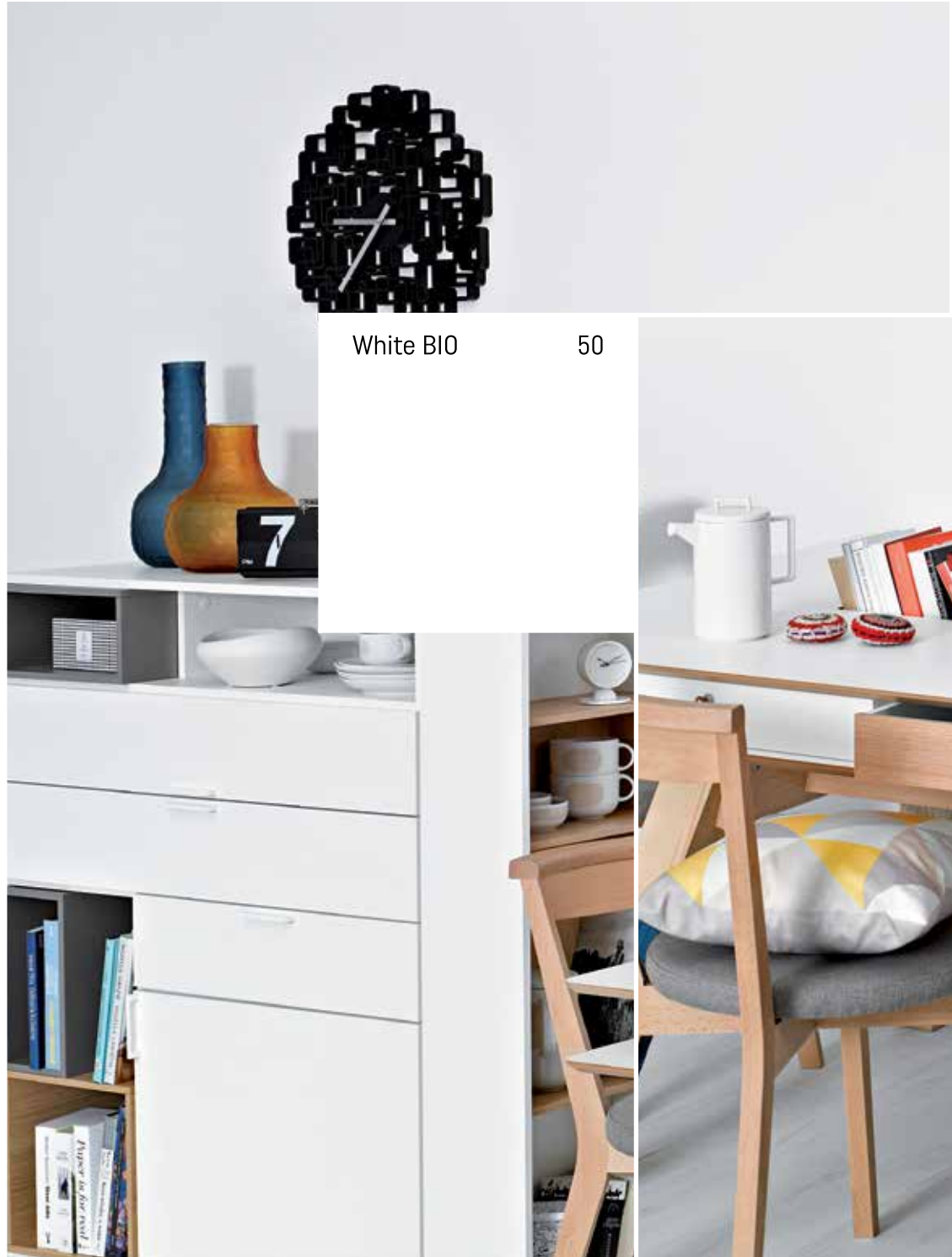



WHITE BIO

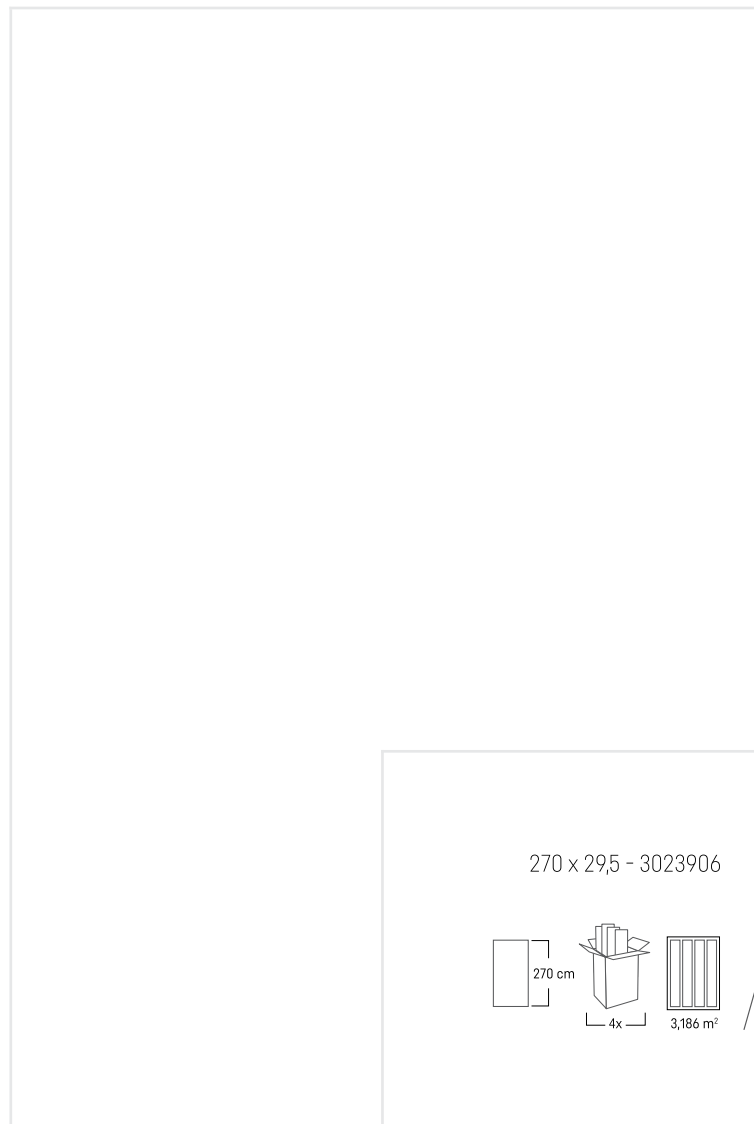

270 x 29,5 - 3023906

300 x 29,5 - 3023905

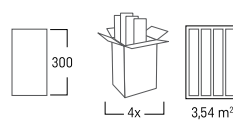
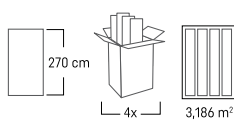



KERRACORE. INNOVATIVE TECHNOLOGY

PROCESS ENGINEERING

The uniqueness of the KERRADECO panels is as a result of KERRACORE production technology.

It applies the cutting-edge techniques and engineering processes.

Material produced with KERRACORE consists of two layers and each of them is a specially designed polymer material.

CUSTOMISED PATTERN

KERRADECO not only offers a wide range of decors and surface finishes but also the option of customised patterns. Our advanced technologies enable us to offer bespoke patterns printed on panels, selected by customers e.g. company logo, graphic sign, etc.

For details ask your local distributor.



The Veterinary Clinic Poland.
Decors used: Stone Moon and
Stone Ivory with customised printing.

1. The bottom layer (foamed)

This layer has exceptional uniformity and density of the cell base, which is achieved by special modifiers used in the latest foaming technologies. This makes the product ideal to fit to the substructure and ensures its water resistance and durability.

water resistance
mechanical strength
dimensional stability
long life

2. The top layer (layer)

Hard polymeric surface, forming the base for a thermally applied pattern, which is finished with digital printing. This structure provides a realistic, natural pattern and structure. Additionally the panels are protected by a layer of UV-cured lacquer.

impact and scratch resistance
realistic structure and patterns
easy cleaning
various decors

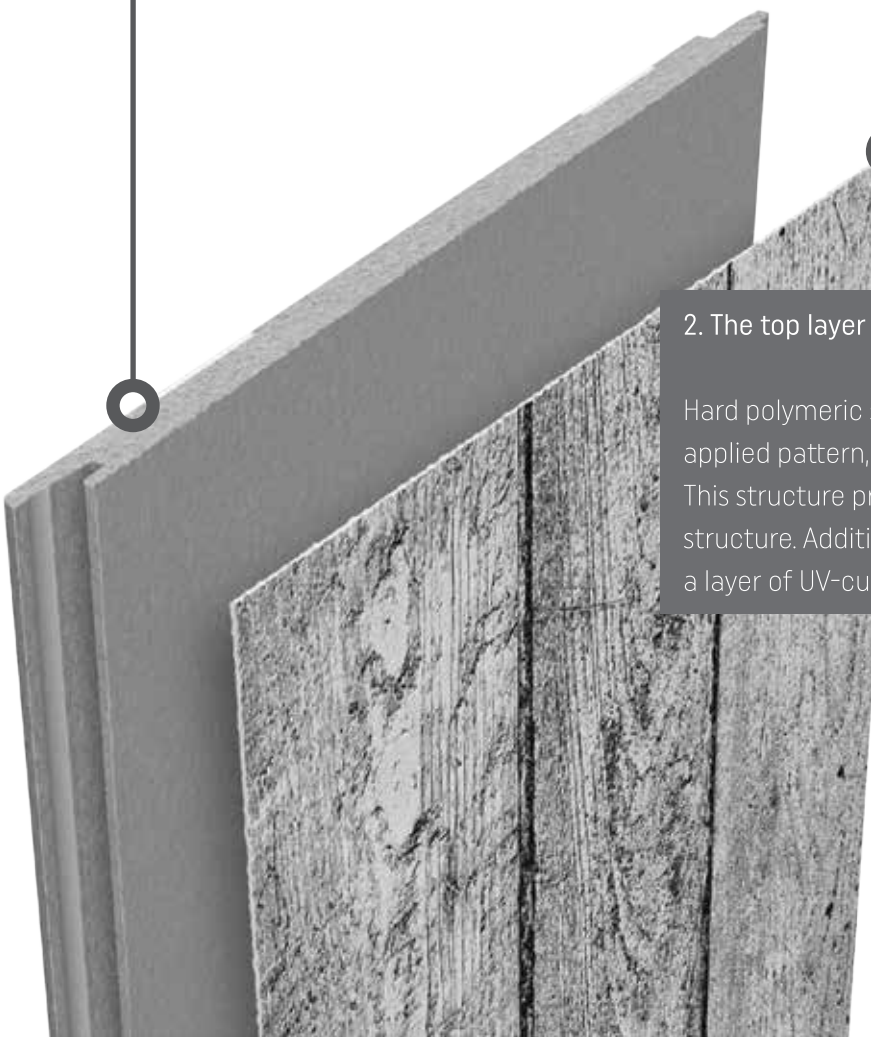

QUICK INSTALLATION

TIME SAVING

One of the many advantages of KERRADECO is its simple and intuitive installation. It saves time and provides additional design options.

WHAT YOU GET?

- two installation options: directly on the wall using adhesive or mounting to wooden battens (using screws)
- easy connection by a tongue and groove system
- connection both on long and a short side (panels 270 cm long have the joint on the long side)
- easy to cut
- installation using standard carpentry tools
- clean installation
- straight, perfectly matched trims (the panels may be installed with or without finishing trims)
- premises ready to use immediately after installation
- quick disassembly (when mounted to a wooden battens)

WHAT YOU AVOID?

- preparation works, including levelling of walls
- dust formation
- wet works
- grouting
- purchasing special tools

ADHESIVE INSTALLATION

Only on stable base (concrete, tiles, plaster-cardboard panels). We recommend the use of a single-component hybrid polymer adhesives, free of solvents and isocyanate.

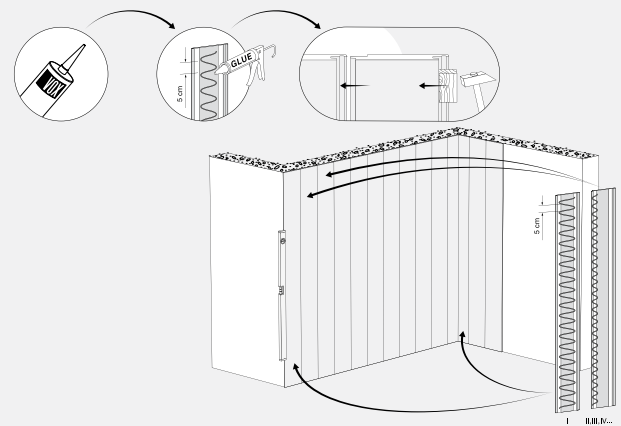

MOUNTING TO A FRAME

With screws - reduces irregularity of walls.

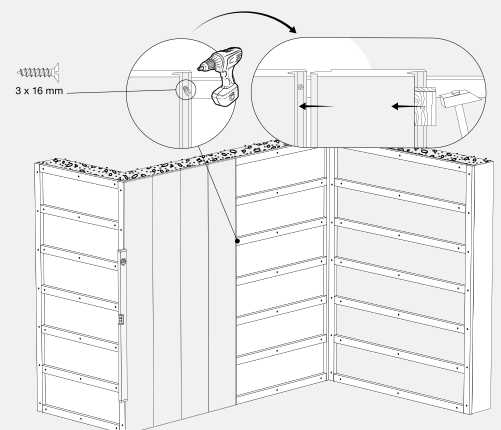

PREPARING THE WALL

a. o. leveling, plaster grinding and priming

KERRADECO

5 min

WALLPAPER

35 min

CERAMIC TILES

35 min

CUTTING AND MOUNTING ON THE WALL

25 min

25 min

80 min

FINISHING WORKS

finishing trims, cleaning

10 min

5 min

10 min

TOTAL INSTALLATION TIME

in min./m²

KERRADECO

40 min

WALLPAPER

1 h 5 min

CERAMIC TILES

2 h 5 min



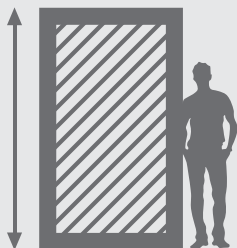











Additional time required for drying adhesive (in case of tiles) - 16 hours



Large dimensions - possibility of covering the entire height of the wall without the need to connect with other panels:

- 270 x 29,5 cm,
- 135 x 29,5 cm.

ADVANTAGES

FEATURE	STANDARD	RESULT OF THE TEST	UNIT
 Weight. Lightweight for easy transport and installation.	-	5,4	kg/m ²
 Dimensions. Large dimensions - possibility of covering the entire height of the wall without the need to connect with other panels.		300 x 29,5 270 x 29,5 135 x 29,5	cm
 Water resistance. Waterproof, allows for use in the shower.			
 Impact resistance.	EN 13245-1	No less than 20 (23.20)	J
 Scratch resistance.	EN 438-2 p.25	3 4	scale N
 Reaction to fire. Non-flammable.	EN 13501-1 BS 476 part 7	B-s3;d0 1	grade
 Acoustic insulation. Comparable to plasterboard.	EN ISO 140-4 EN ISO 717-1	Less than Rw=60	dB
 Thermal conduction. Thermal insulation comparable to styrophone board 5,6 mm.	EN 12664	$\lambda=0,065$	W/(m·K)
 UV resistance.	EN ISO 4892-2 EN 20105-102	No less than 3 in greyscale	scale
 Global migration to food substances. Safe in contact with food.	EN 1186-1 EN 1186-3 EN 1186-14	Ethanol 10%: <0,3 3% acetic acid: 7,8 ± 0,9 95% ethanol 0,3 ± 0,1	mg/dm ³
 Does not contain lead and tin.			
 Produced from recycled products. 100% suitable for recycling.			
 10-year guarantee on the product.			
 Emissions of harmful substances. No emissions.	ISO 16000	A+	grade

PRODUCT AND ACCESSORIES

PANELS

KERRADECO products are available in several sizes, so you can easily adapt them to the dimensions of the wall surface - without cutting, joining or adjusting the height of the panels. A full set of skirting boards with a length of 2,7 m, available in two colors, provides an elegant finish to any wall.

KERRADECO

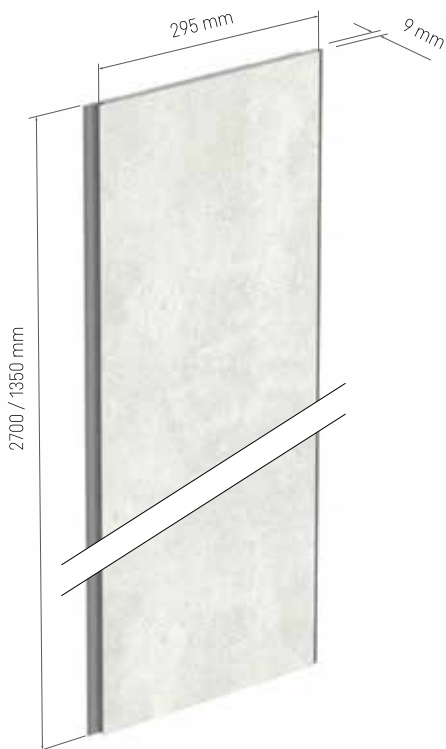

FINISHING TRIMS

A-01

Starting trim

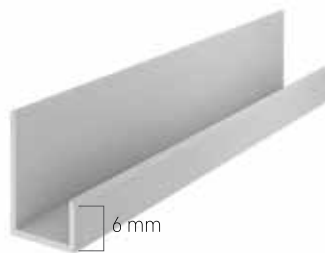

A-03

External angle - 1

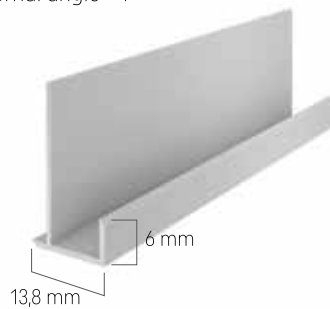

A-02

Internal angle

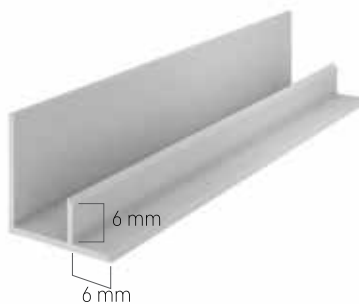

A-05

Top edge trim

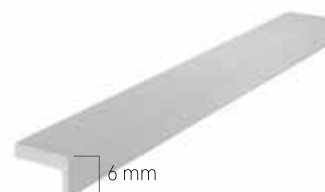

COLOUR RANGE

KERRADECO finishing trims are available in two colors: silver and champagne.











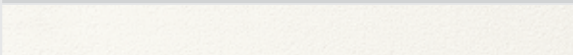
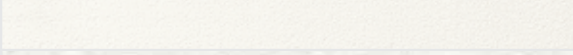













KERRADECO
Silver

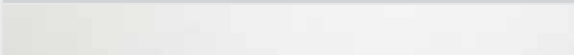

KERRADECO
Champagne

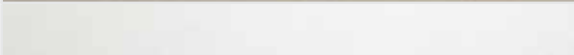
SUMMARY

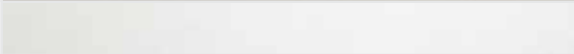
PANELS			
	INDEX	STONE LINE	DIMENSIONS
	3021912	Stone Ivory	135 x 29,5 x 0,9
	3023893	Stone Ivory	270 x 29,5 x 0,9
	3021872	Stone Misty	135 x 29,5 x 0,9
	3022282	Stone Misty	270 x 29,5 x 0,9
	3021880	Desert Stone	135 x 29,5 x 0,9
	3022096	Stone Moon	135 x 29,5 x 0,9
	3021809	Stone Anthracite	135 x 29,5 x 0,9
	3021811	Stone Anthracite	270 x 29,5 x 0,9
	3021913	Loft Concrete	135 x 29,5 x 0,9
	3023461	Loft Rusty	135 x 29,5 x 0,9
	3022097	Marble Botticino	135 x 29,5 x 0,9
		WOOD LINE	
	3022238	Snowy Wood	135 x 29,5 x 0,9
	3022104	Wood Brandy	135 x 29,5 x 0,9
	3022105	African Wood	135 x 29,5 x 0,9
	3021871	Wood Carbon	135 x 29,5 x 0,9
	3022468	Wood Vintage	135 x 29,5 x 0,9
	3021908	Concrete	135 x 29,5 x 0,9
	3021903	Concrete	270 x 29,5 x 0,9
	3009204	Art	270 x 29,5 x 0,9
		TEXTILE	
	3023441	Scotch	135 x 29,5 x 0,9
	3021878	Scotch	270 x 29,5 x 0,9
		UNICOLOR	
	3023906	White BIO	270 x 29,5 x 0,9
	3023905	White BIO	300 x 29,5 x 0,9

FINISHING TRIMS			
	INDEX		DIMENSIONS
	6004008	A-01 Starting trim, silver	270
	6004009	A-01 Starting trim, champagne	270
	6004010	A-05 Top edge trim, silver	270
	6004011	A-05 Top edge trim, champagne	270
	6004012	A-02 Internal angle, silver	270
	6004013	A-02 Internal angle, champagne	270
	6004014	A-03 External angle - 1, silver	270
	6004015	A-03 External angle - 1, champagne	270
	6004018	UNIVERSAL ASSEMBLY ADHESIVE	290 ml





vox.pl

Profile VOX Sp. z o.o. sp. k.
ul. Gdynska 143
62-004 Czerwonak
Poland

voxindia.co

VOX Building Products Pvt. Ltd
6th Floor, Leela Collonnade, The Leela Palace, No. 23, HAL, Old Airport Rd,
Bengaluru - 560008, India
P: +91 80 4374 1810, E: customer@voxindia.co

